

Zennio[®]



Z41
TOUCH PANEL

KNX[®]

InZennio Z41

Capacitive Color Touch Panel



InZennio Z41 (ZN1VI-TP41C)

KNX 4,1" Capacitive Color Touch Panel

Technical specifications

- Black, white or silver frame
- External Power Supply: 12-29V AC
- Magnetic fit
- Real Time Clock (RTC)
- Ethernet and USB ports
- Standby Mode: energy saving
- KNX BCU included
- Total Data Saving when Power Failure occurs
- CE compliant



InZennio Z41 (ZN1VI-TP41C)

KNX 4,1" Capacitive Color Touch Panel

Different finishes



ZN1VI-TP41C-W



ZN1VI-TP41C-S



ZN1VI-TP41C-A

InZennio Z41 (ZN1VI-TP41C)

KNX 4,1" Capacitive Color Touch Panel

Functionality

- 6 completely configurable pages (8 boxes each):

INDICATORS	1 BUTTON	2 BUTTON	CLIMATE	OTHER
<ul style="list-style-type: none"> • Binary (icon) • Binary (text) • Enumerated (icon) • Enumerated (text) • 1 byte (unsigned int) • 1 byte (signed int) • 1 byte (percentage) • 2 bytes (unsigned int) • 2 bytes (signed int) • 2 bytes (float) 	<ul style="list-style-type: none"> • Binary • 1 byte constant (unsigned int) • 1 byte constant (signed int) • 1 byte constant (percentage) • 2 bytes constant (unsigned int) • 2 bytes constant (signed int) • 2 bytes constant (float) • Scene 	<ul style="list-style-type: none"> • Binary (icon) • Binary (text) • Enumerated (icon) • Enumerated (text) • 1 byte (unsigned int) • 1 byte (signed int) • 1 byte (percentage) • 2 bytes (unsigned int) • 2 bytes (signed int) • 2 bytes (float) • Two Button Scene • Shutter • Light dimming 	<ul style="list-style-type: none"> • Setpoint • Mode • Fan • Special Mode 	<ul style="list-style-type: none"> • RGB • RGBW • Energy Monitor • Daily Timer • Weekly Timer • Alarm

InZennio Z41 (ZN1VI-TP41C)

KNX 4,1" Capacitive Color Touch Panel

Functionality

- Configuration page: time, date, alarm log.
- Profile page: theme, volume.
- Internal temperature probe.
- 2 Independent thermostats.

InZennio Z41 (ZN1VI-TP41C)

KNX 4,1" Capacitive Color Touch Panel

Functionality

- 8 Themes:

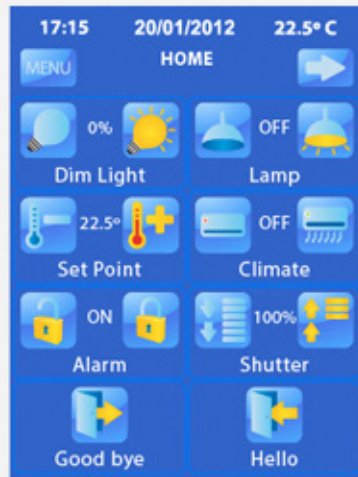

OCEAN

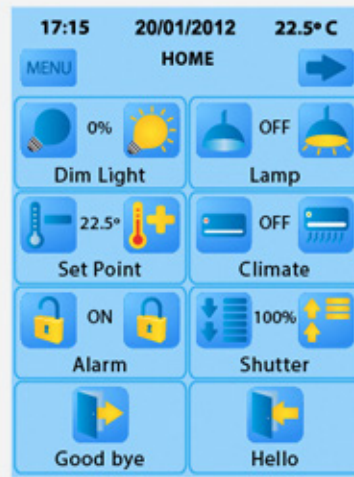

SKY

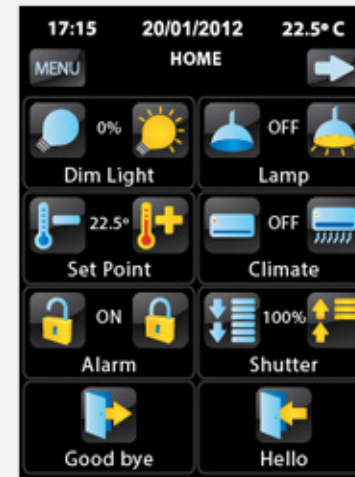

NIGHT

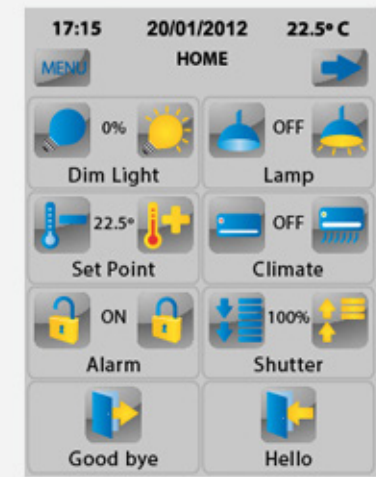

TWILIGHT

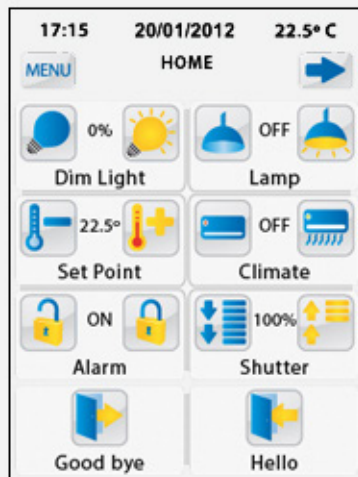

EGG SHELL

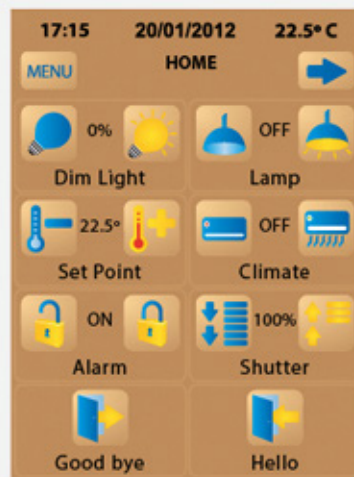

SEASIDE

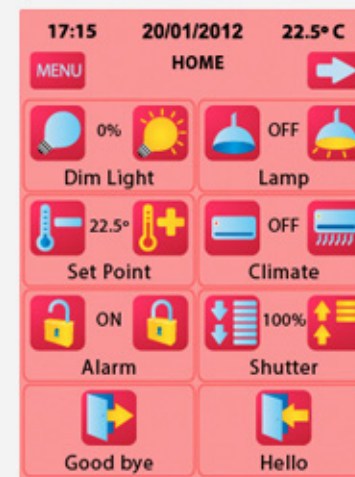

RIOJA

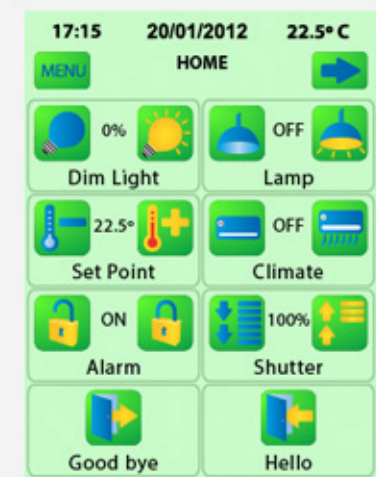

FOREST

InZennio Z41 (ZN1VI-TP41C)

KNX 4,1" Capacitive Color Touch Panel

Special controls and indicators

- RGB(W) control

- Timers



InZennio Z41 (ZN1VI-TP41C)

KNX 4,1" Capacitive Color Touch Panel

Special controls and indicators

- Energy consumption graphics

Power (KW)

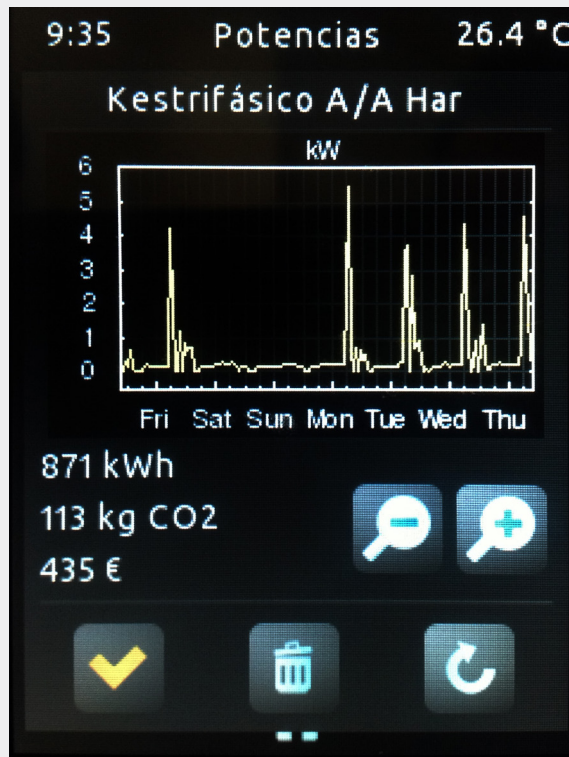

Total energy (KW/h)

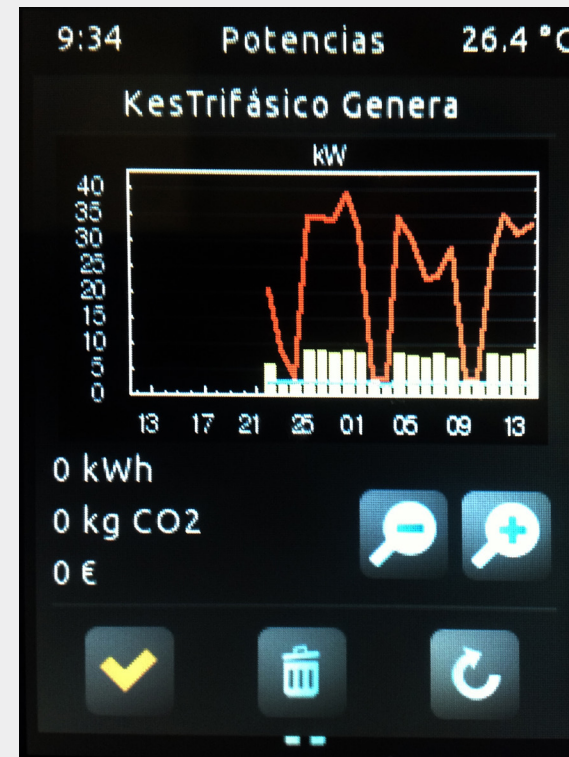

InZennio Z41 (ZN1VI-TP41C)

KNX 4,1" Capacitive Color Touch Panel

Special controls and indicators

- Energy consumption graphics

CO2 emissions (Kg/KWh)



Cost

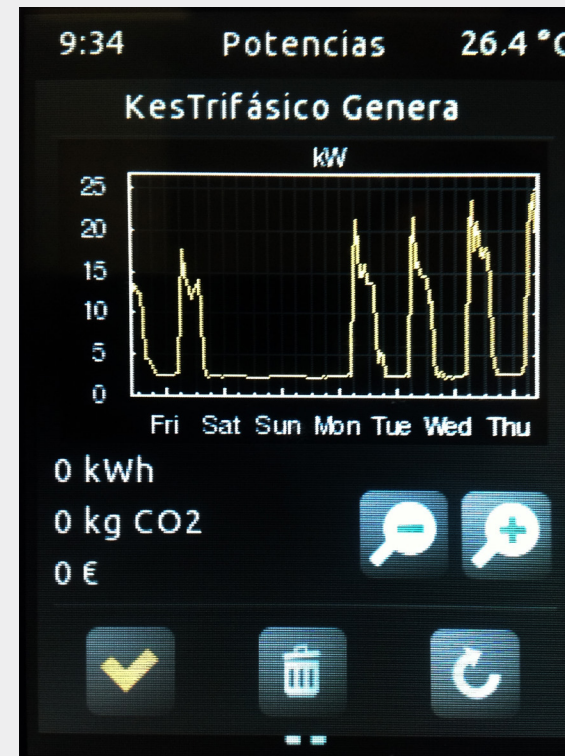

InZennio Z41 (ZN1VI-TP41C)

KNX 4,1" Capacitive Color Touch Panel

Special controls and indicators

- Numeric indicators graphics

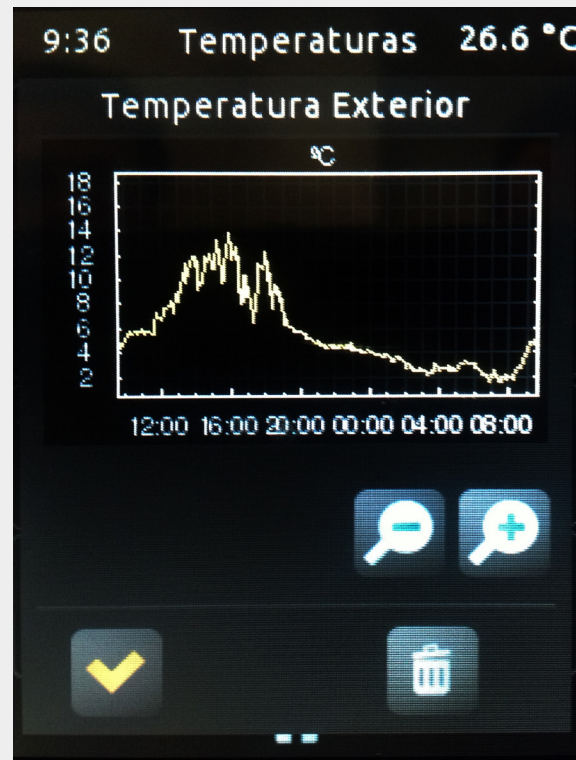
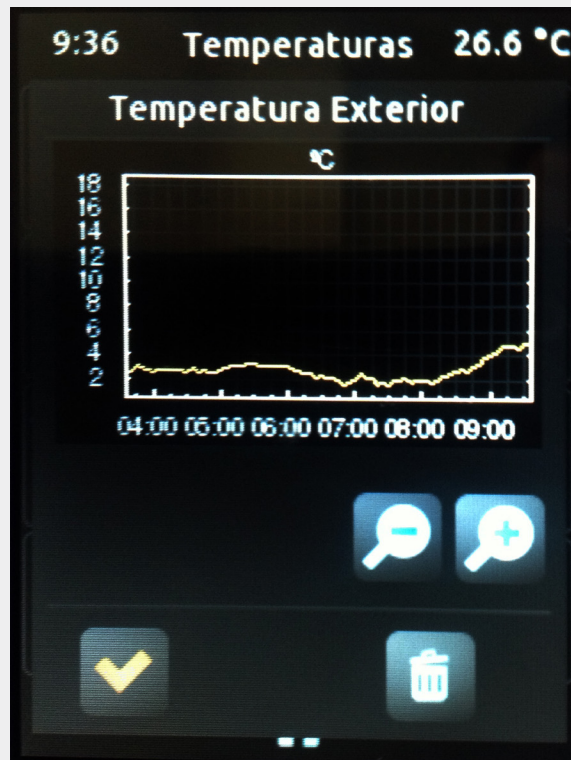

InZennio Z41 (ZN1VI-TP41C)

KNX 4,1" Capacitive Color Touch Panel

Special controls and indicators

- Technical alarms (alarm log)

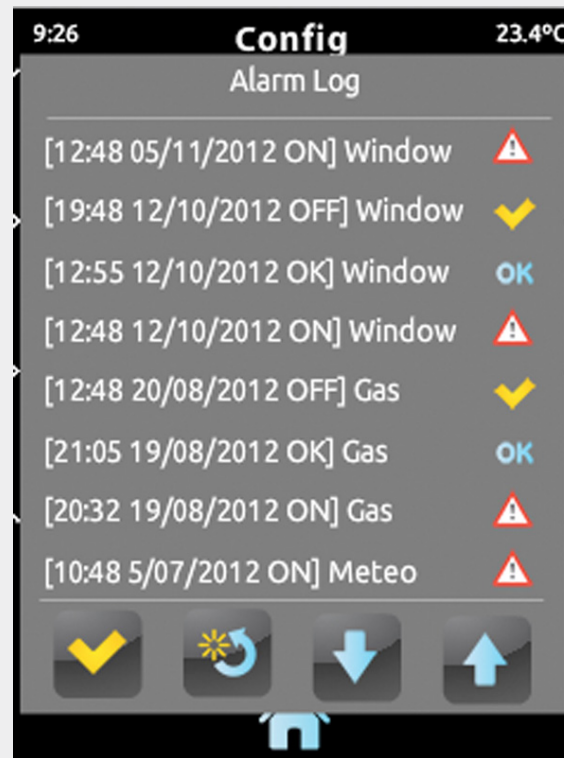

InZennio Z41 (ZN1VI-TP41C)

KNX 4,1" Capacitive Color Touch Panel

Timers

- Daily timer
- Weekly timer



InZennio Z41 (ZN1VI-TP41C)

KNX 4,1" Capacitive Color Touch Panel

Installation

- Wall mounting in 60x60mm. box or 65 diameter circle

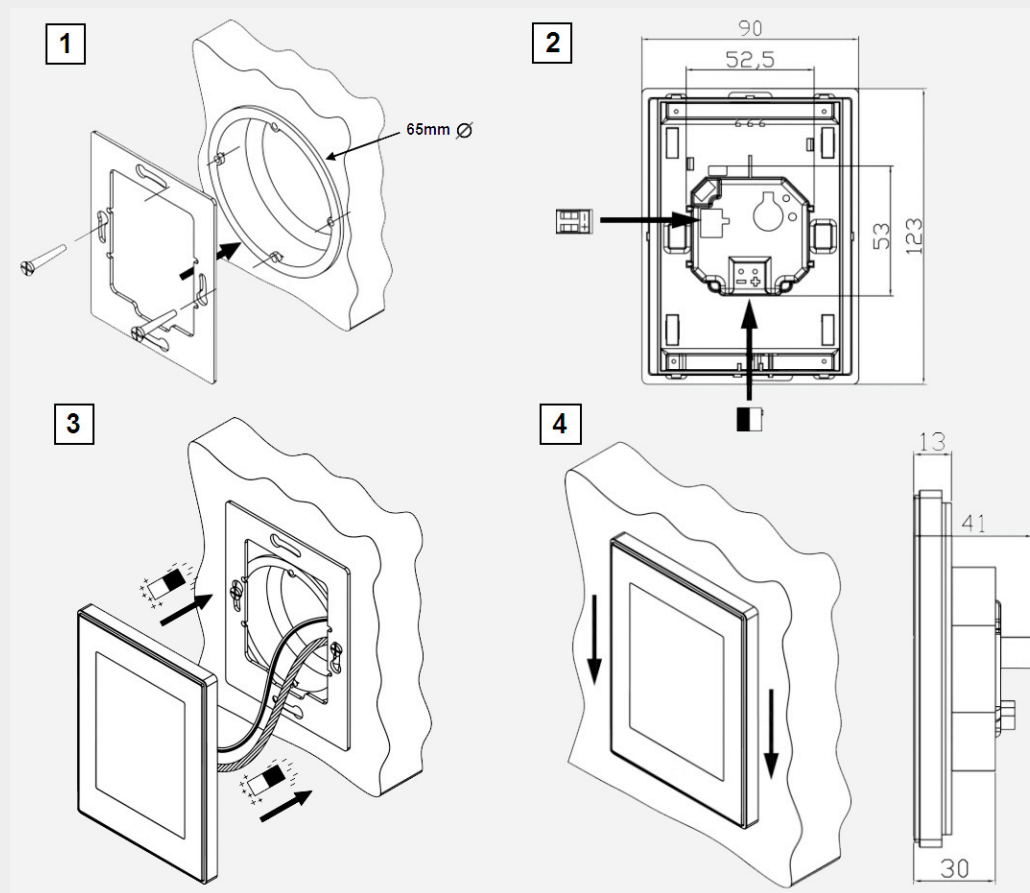

www.zennio.com